

1 : Coat Hangers X 2  
 2 : News Paper  
 3 : Scissors  
 4 : Tape  
 5 : Fabric

6 : Clothes Pegs  
 7 : Water  
 8 : PVA Glue  
 9 : Mixing Bucket

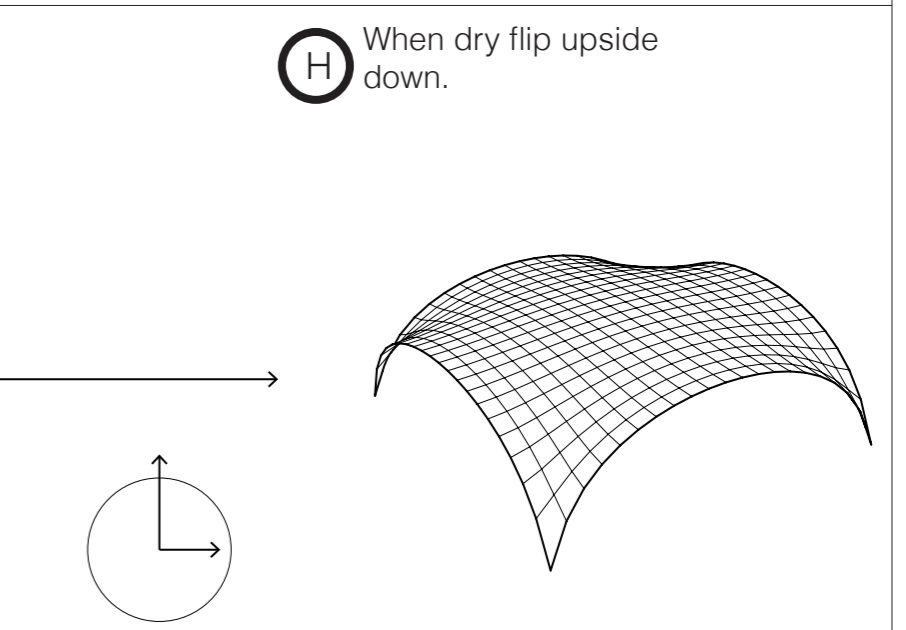

**G** Wait til dry, maybe build another one?

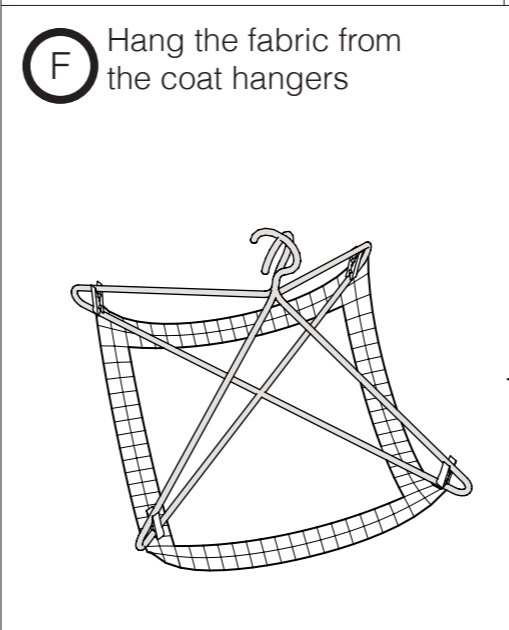
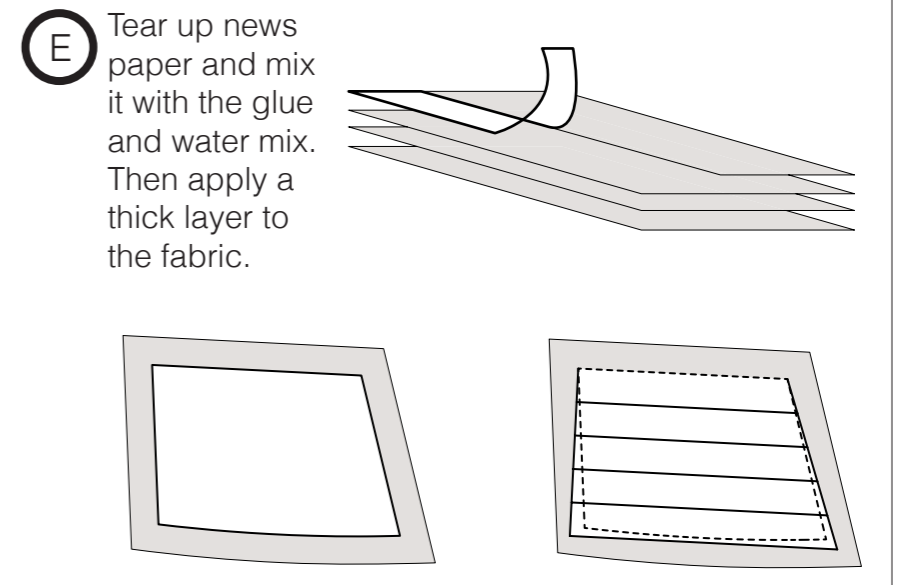
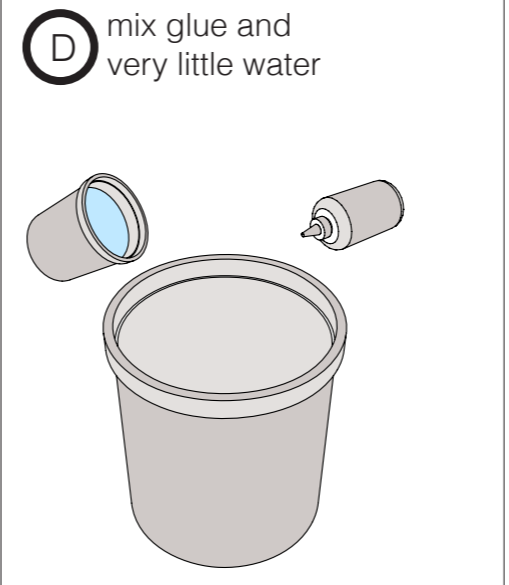
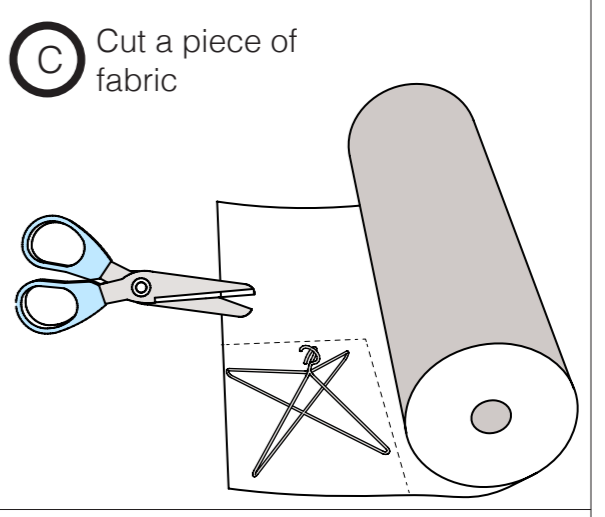
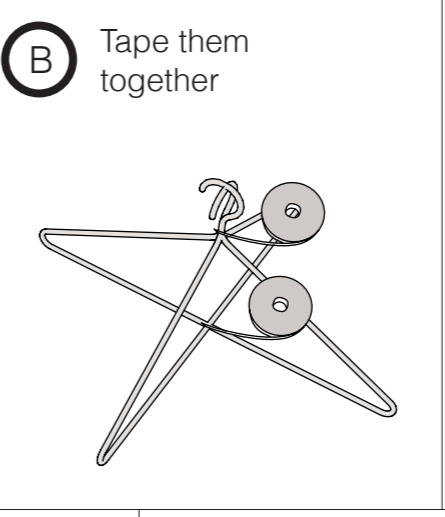
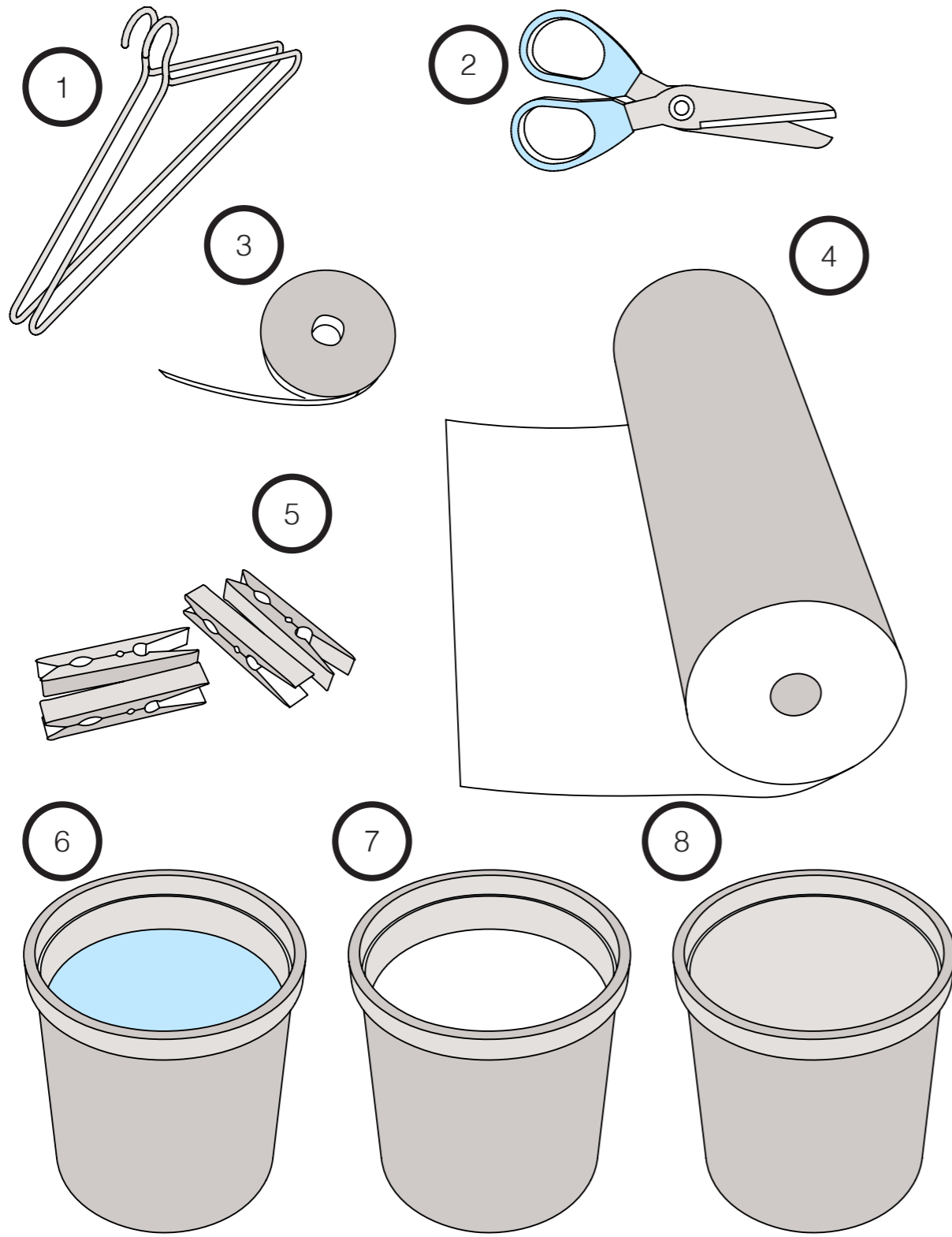

1 : Coat Hangers X 2  
 2 : Scissors  
 3 : Tape  
 4 : Fabric

5 : Clothes Pegs  
 6 : Water  
 7 : Plaster Powder  
 8 : Mixing Bucket

**A** take the 2  
 clothe hangers

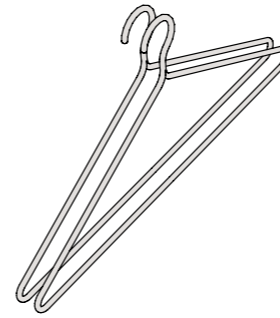

**B** Tape them  
 together

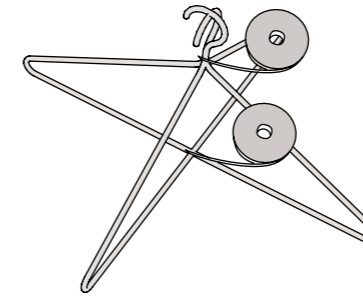

**C** Cut a piece of  
 fabric

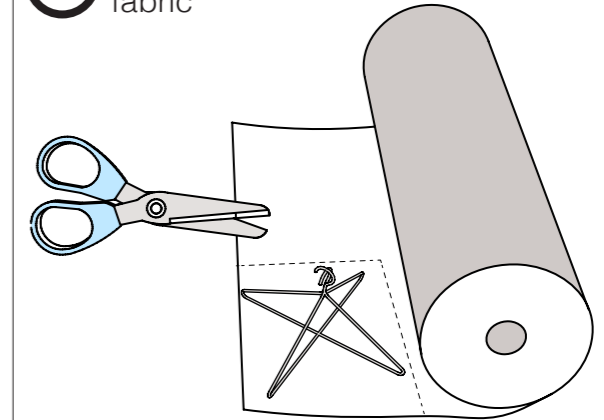

**D** Mix plaster and  
 water - ask for  
 correct mixture.

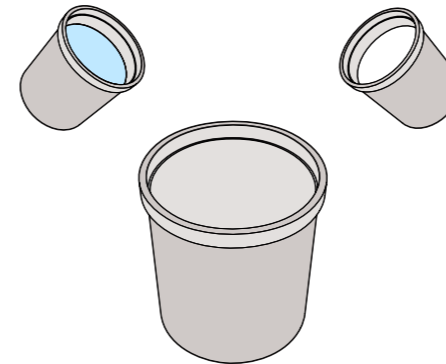

**E** Apply the plaster  
 in a medium thick  
 layer to the fabric

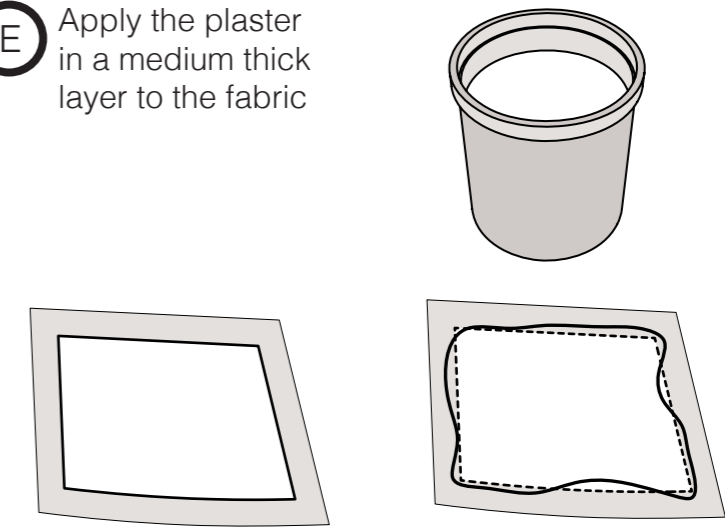

**F** Hang the fabric from  
 the coat hangers

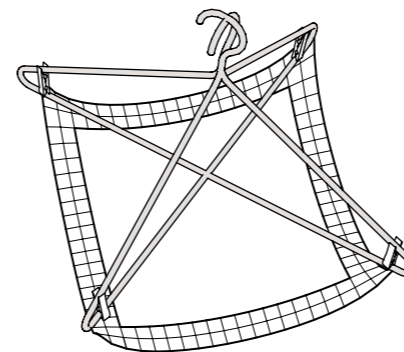

**H** When dry flip upside  
 down.

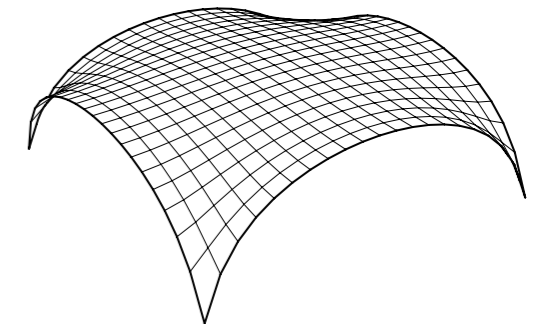

**G** Wait til dry, maybe  
 build another one?

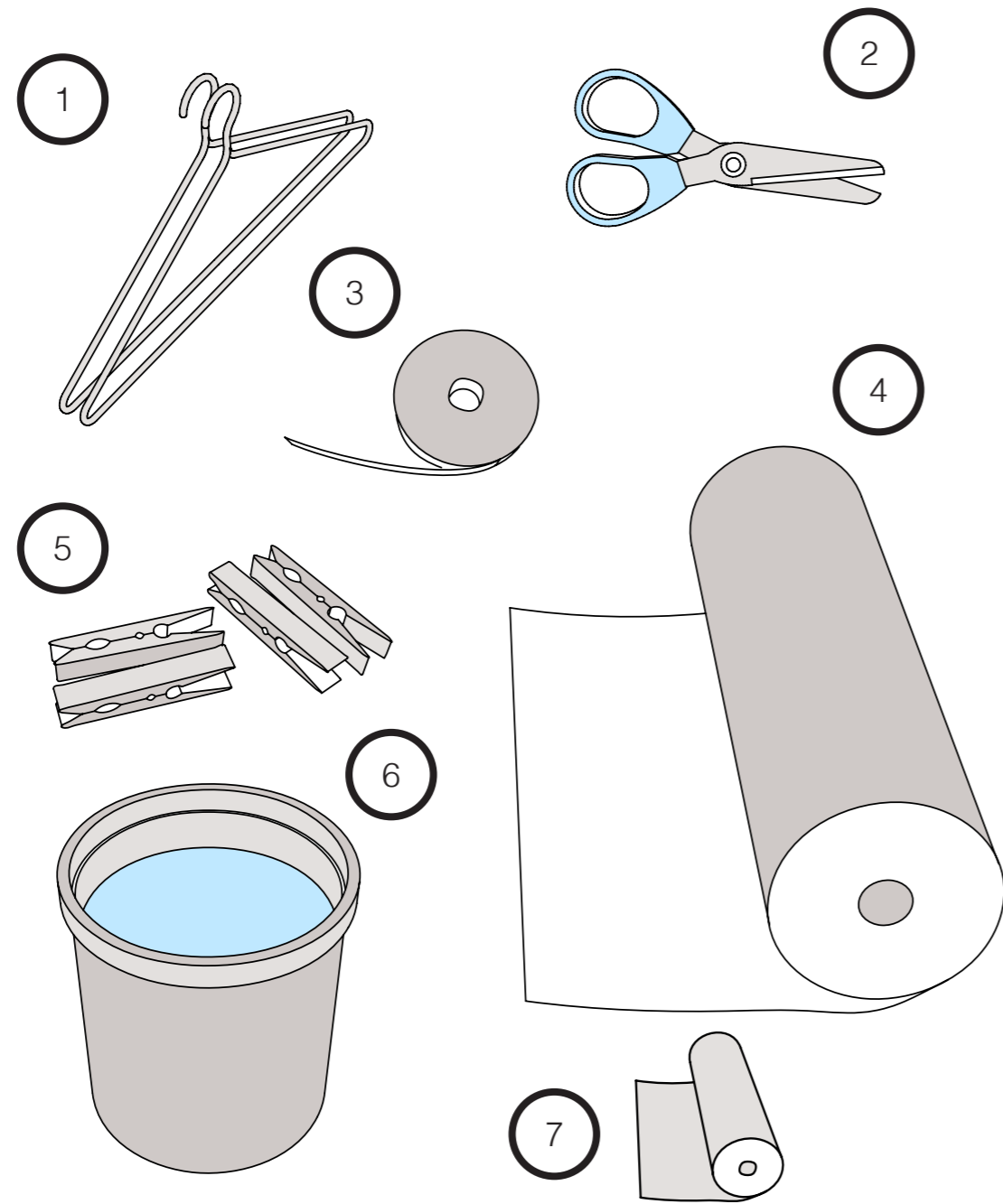

1 : Coat Hangers X 2  
 2 : Scissors  
 3 : Tape  
 4 : Fabric

5 : Clothes Pegs  
 6 : Water  
 7 : Modroc (1 roll)

**A** take the 2  
 clothe hangers

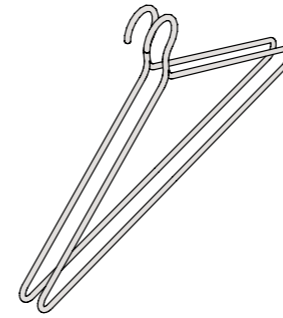

**B** Tape them  
 together

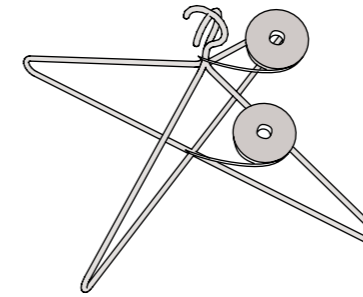

**C** Cut a piece of  
 fabric

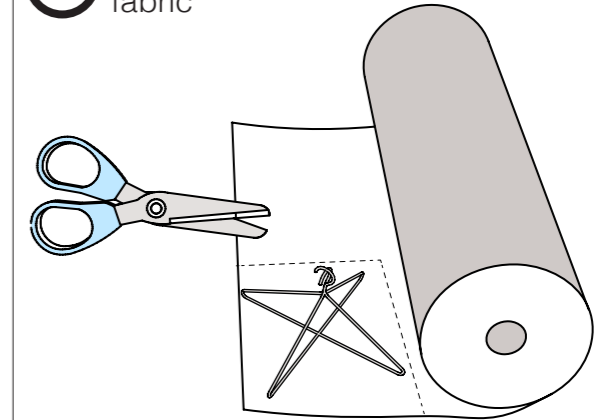

**D** Cut mod roc into  
 strips, and dip them in  
 water and apply them  
 in a medium thick  
 layer on the fabric.  
 Smooth the modroc  
 with your hands if  
 necesary.

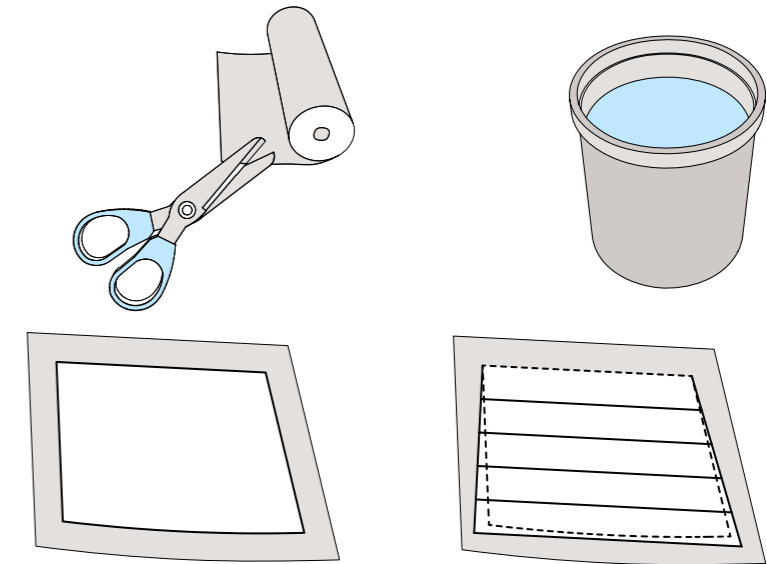

**E** Hang the fabric from  
 the coat hangers

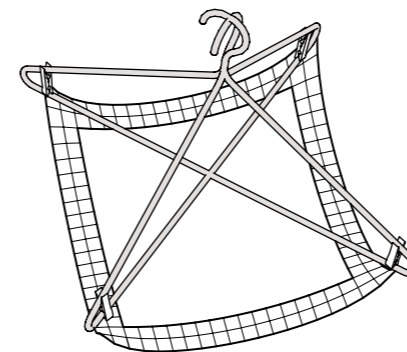

**G** When dry flip upside  
 down.

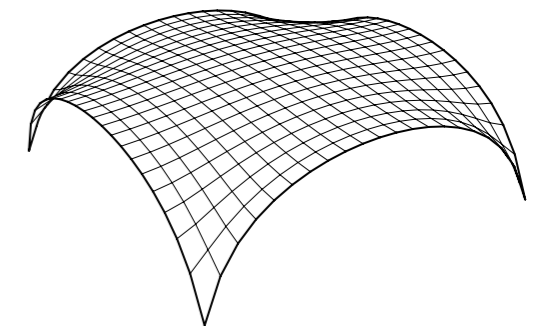

**F** Wait til dry, maybe  
 build another one?

